

SSABS/SCTFDR/NINAV3/RAD04/BVA4

X84  
03

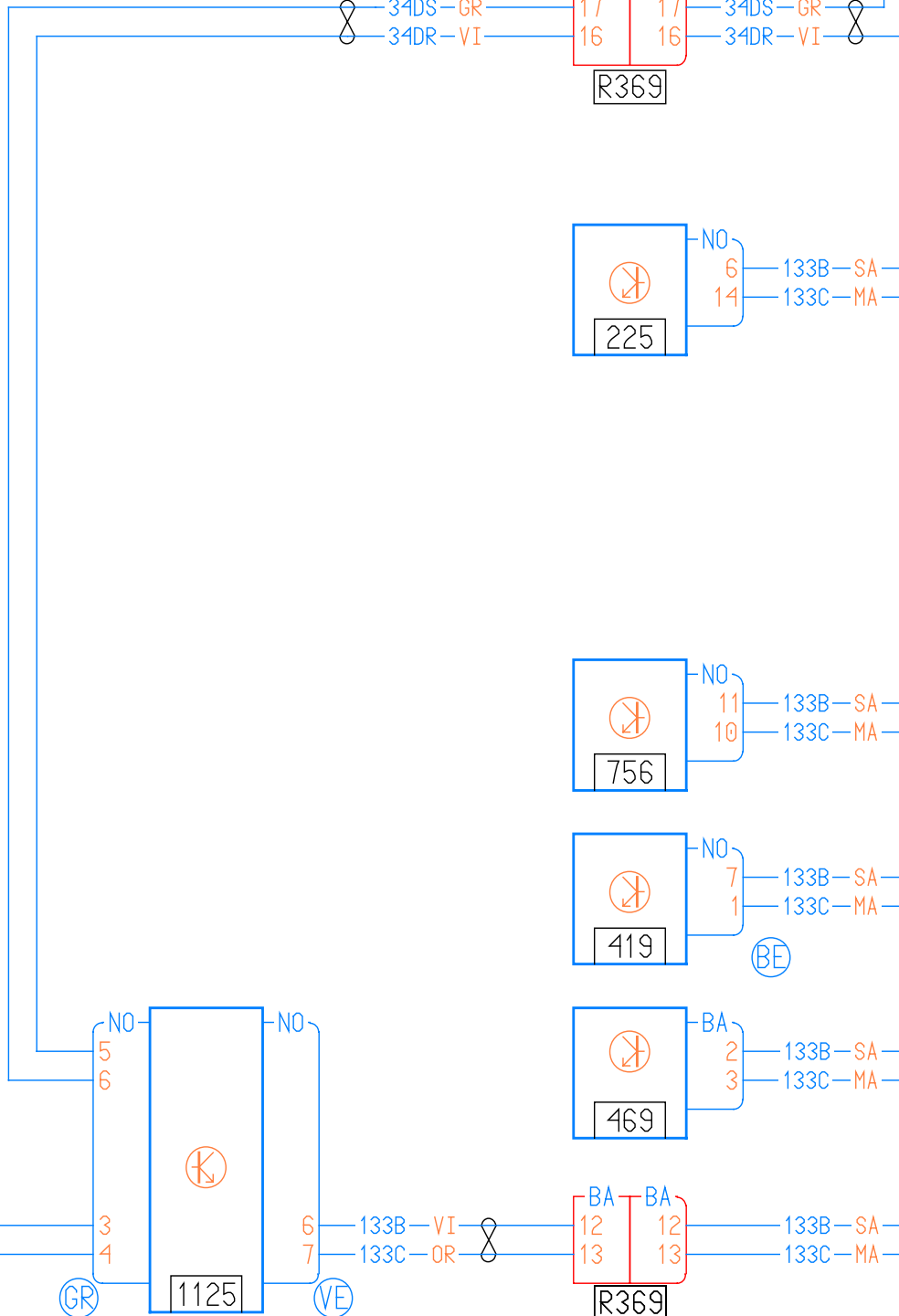

3-245

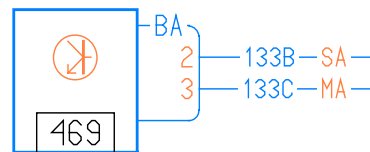
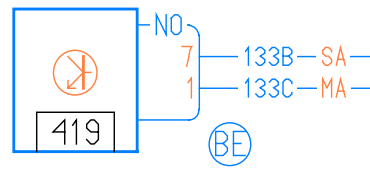
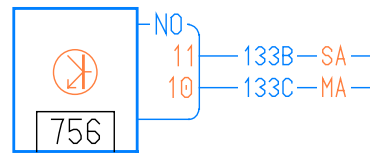
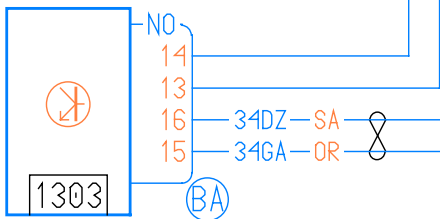
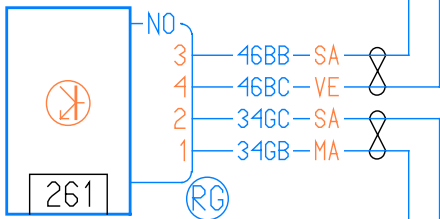
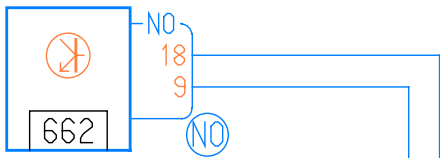
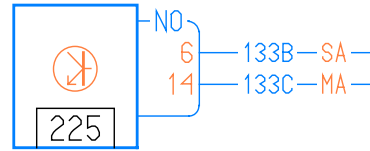
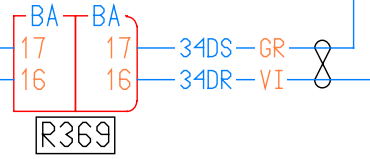
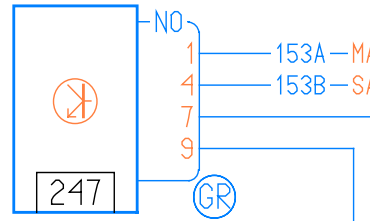