

ABS/SCTFDR/EQGPL/NINAV3/RAD04

X84
03

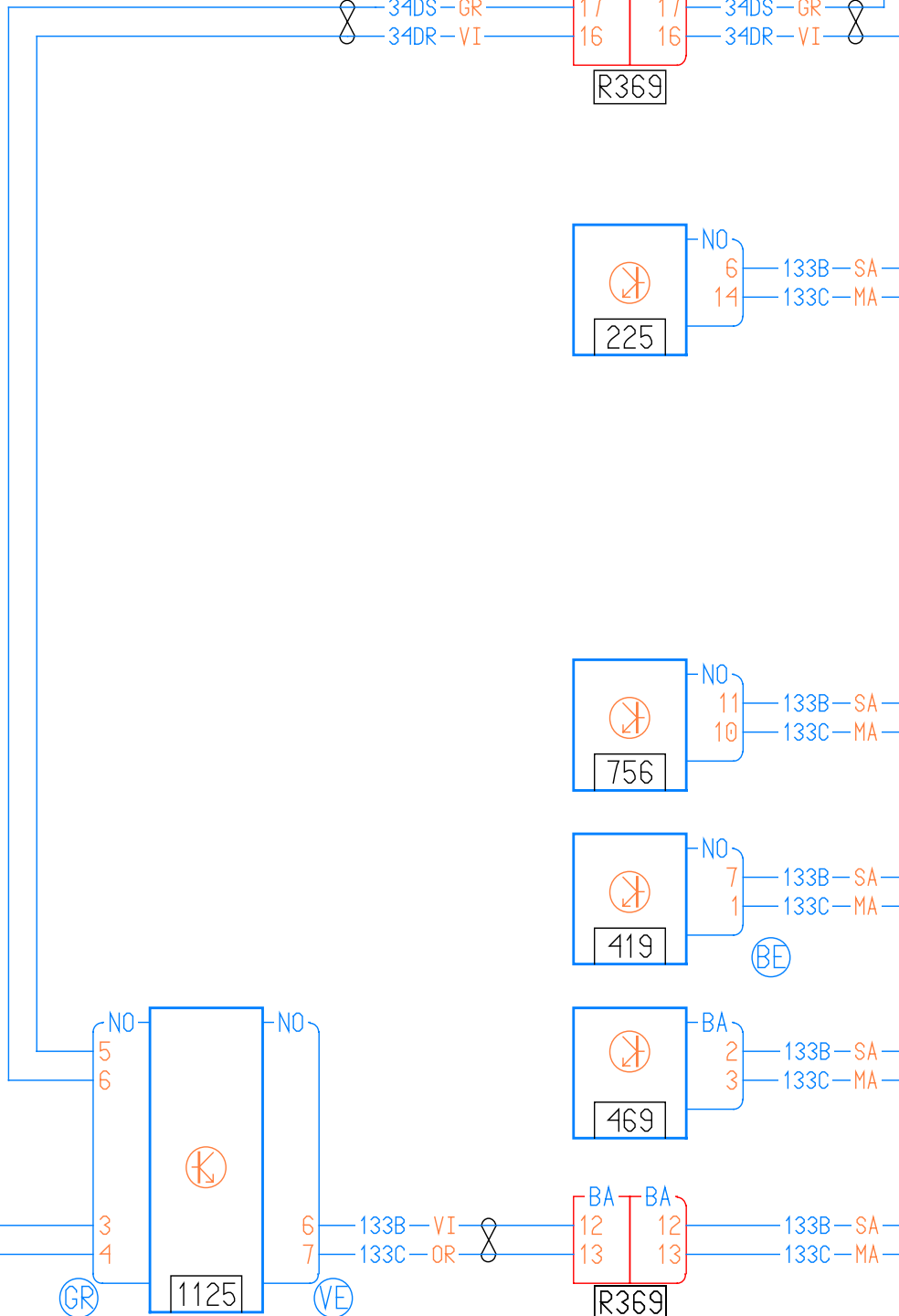

3-242

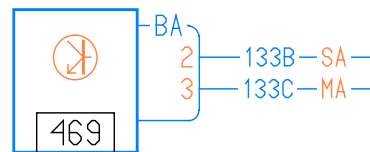
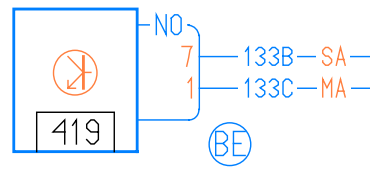
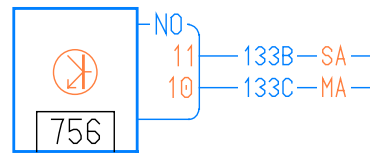
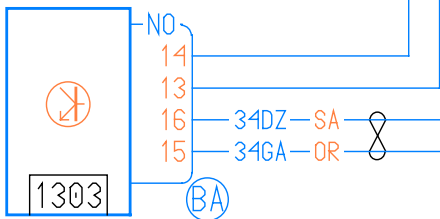
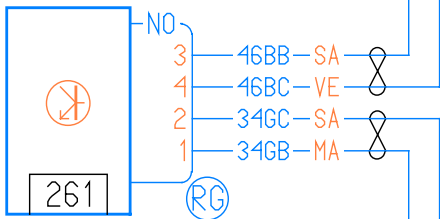
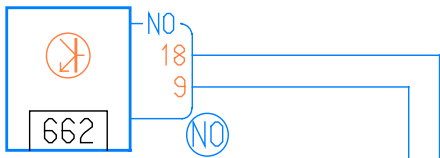
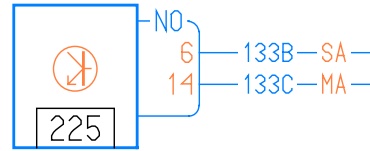
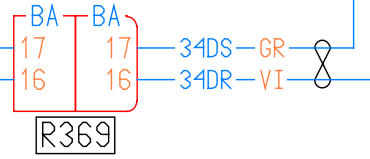
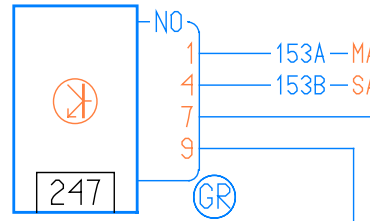