

X74
05

SUPCPE/LVAREL

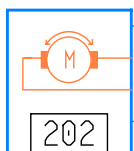

3-127

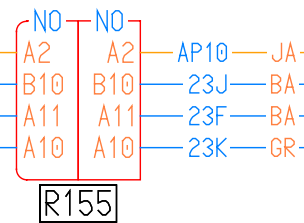
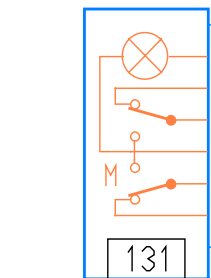
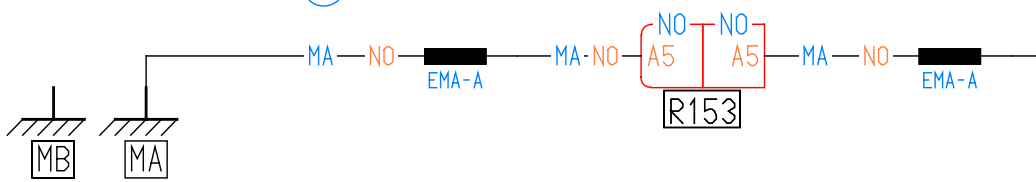
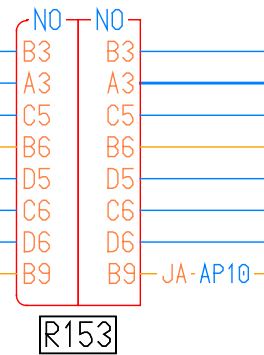
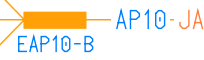
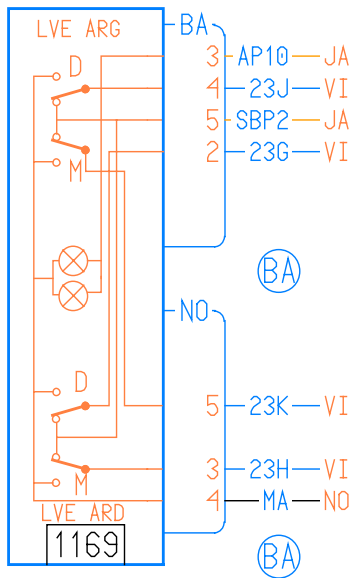
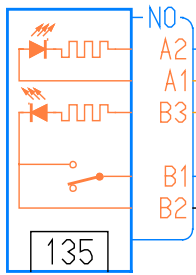